

Article number: 12309000080100
Description: KLEE-coil 309 000 080.100
M8 Unhardened steel

Measures

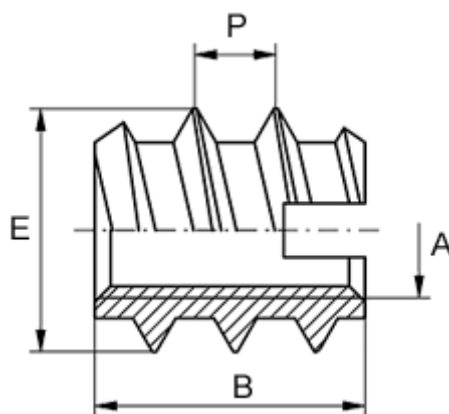

Female thread A	= M8
Length B	= 20
Male thread E	= 13.0
Min hole depth	= 23
Recommended bore diameter (plastic/hard wood)	= 10.1 to 10.3
Recommended bore diameter, soft wood (largest)	= 10.0
Thread pitch P	= 4.0